

## Reclining Phlebotomy Chair Manually adjustable with gas-spring assistance

### Features

- ▶ Highly finished white epoxy-coated steel chassis
- ▶ Gas-spring assisted manual operation of back and leg supports with synchronised movement
- ▶ Armrests are adjustable for height, tilt and rotation. They may be rigidly clamped in any position
- ▶ Back and leg rests are height and inclination adjustable with gas-spring assistance

### Specifications

- Seat height 50cm



### MR5160 Chair with wheels

**£995**

exc VAT & Delivery\*

### MR2000 Spare Pad for Arm Rest

**£56**

exc VAT & Delivery\*



### Accessories



#### MZ 5048

Paper holder

**£24**

exc. VAT & Delivery



#### MZ 5059

Anatomic Headrest

**£80**

exc. VAT & Delivery

### DIMENSIONS

LENGTH	WIDTH	HEIGHT	WEIGHT
170cm	80cm	125cm	35kg

### UPHOLSTERY COLOURS:

Please specify code and colour when ordering.

008728 GRAU	008731 SAFRAN	008726 MELONE	008722 ROT	010682 ORANGE
014129 PISTAZIE	014128 AZUR	008721 DELFT	008716 SCHWARZ	

\*This item is delivered cased and palletised.

**THIS CHAIR IS FOR MEDIUM USAGE**  
(1-100 PATIENTS PER DAY)

**Max. patient weight: 23 stone (150kg)**

Patients should avoid using the chair arms for support when leaving the chair.

# ZAP11601

## Features

- ▶ The seat, the leg rest and the backrest are molded out of cold-foamed integral polyurethane (fireproof) and this allows the maximum comfort for patient in order to prevent decubitus ulcers.
- ▶ Backrest is equipped with push handle.
- ▶ Synchronized bilateral control for backrest and leg rest through gas-spring.
- ▶ Armrests are padded and upholstered, shaped for a better position of the arms and adjustable in all positions
- ▶ Four steel feet with end part made of non-slip plastic
- ▶ All materials are treated with anti-bacterial additive INTERPON.
- ▶ ANTI-SHOCK or TRENDELENBERG position:
  - Backrest from -5° to +100°
  - Leg-rest from -90° to +14°

## ZAP11601

# £970

ex VAT & delivery

## Reclining Phlebotomy Chair

The armchair is entirely made of tubular steel varnished with epoxy powders which allow high mechanical, chemical and corrosion resistance. The backrest has a steel structure, while the leg rest and seat are made of solid anti-humidity multilayer beech-wood panels, consisting of several sheets and wood fibres.



## MR2000 Spare Pad for Arm Rest

# £56

ex VAT & delivery

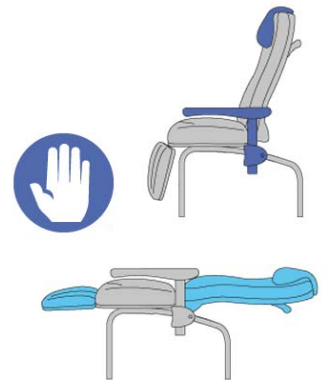

## MZ5048

Paper holder

# £24

ex VAT & delivery

### UPHOLSTERY COLOURS:

Please specify colour when ordering.

VANILLE	SAFRAN	ORANGE	ROT	DELFT
TÜRKIS	AZUR	PARAKEET	PISTAZIE	GRAU

\*This item is delivered cased and palletised.

### DIMENSIONS

WIDTH	LENGTH	DEPTH	WEIGHT
72cm	90cm	123cm	35Kg
with backrest down			
72cm	174.5cm	72cm	35Kg

**SAFE WORKING LOAD 150Kg**

**AP1164**

Reclining Phlebotomy Chairs

**Features**

- ▶ The seat, the leg rest and the backrest are padded following different thickness and are upholstered with imitation leather which is fireproof class 1 IM, washable and disinfectable.
- ▶ Backrest is equipped with push handle.
- ▶ Synchronized bilateral control for backrest and leg rest through gas-spring.
- ▶ Armrests are padded and upholstered, shaped for a better position of the arms and adjustable in all positions
- ▶ ANTI-SHOCK or TRENDELENBERG position:
  - Backrest from -5° to +100°
  - Leg-rest from -90° to +14°

**Reclining Phlebotomy Chair**

The armchair is entirely made of tubular steel varnished with epoxy powders dried at a temperature of 250°. The backrest has a steel structure, while the leg rest and seat are made of solid anti-humidity multilayer beech-wood panels, consisting of several sheets and wood fibres.

**AP1164**  
**£1025**

ex VAT & delivery



**MR2000 Spare Pad for Arm Rest**

**£56**

ex VAT & delivery



**MZ5048**

Paper holder

**£24**

ex VAT & delivery

\*Available with 2 or 4 braked wheels (2 as standard)

**UPHOLSTERY COLOURS:**

Please specify colour when ordering.

VANILLE	SAFRAN	ORANGE	ROT	DELFT
TÜRKIS	AZUR	PARAKEET	PISTAZIE	GRAU

\*This item is delivered cased and palletised.

**DIMENSIONS**

WIDTH	LENGTH	DEPTH	WEIGHT
72cm	90cm	123cm	35Kg
with backrest down			
72cm	174.5cm	72cm	35Kg

**SAFE WORKING LOAD 150Kg**

**AP1180**

# Reclining Phlebotomy Chair

## Hydraulic operation

The armchair is entirely made of tubular steel varnished with epoxy powders dried at a temperature of 250°. The backrest has a steel structure, while the leg rest and seat are made of solid anti-humidity multilayer beech-wood panels, consisting of several sheets and wood fibres.



**AP1180**  
**£1855**

ex VAT & delivery



## MR2000 Spare Pad for Arm Rest

**£56**

ex VAT & delivery



### Features

- ▶ The seat, the leg rest and the backrest are padded following different thickness and are upholstered with imitation leather which is fireproof class 1 IM, washable and disinfected.
- ▶ Backrest is equipped with push handle.
- ▶ Synchronized bilateral control for backrest and leg rest through gas-spring.
- ▶ Armrests are padded and upholstered.
- ▶ ANTI-SHOCK or TRENDELENBERG position:
  - Backrest from -5° to +100°
  - Leg-rest from -90° to +14°

\*Available with 2 or 4 braked wheels (2 as standard)

### UPHOLSTERY COLOURS:

Please specify colour when ordering.

VANILLE	SAFRAN	ORANGE	ROT	DELFT
TÜRKIS	AZUR	PARAKEET	PISTAZIE	GRAU

\*This item is delivered cased and palletised.

### DIMENSIONS

WIDTH	LENGTH	DEPTH	WEIGHT
72cm	90cm	123cm	35Kg
with backrest down			
72cm	174.5cm	72cm	35Kg

**SAFE WORKING LOAD 150Kg**

# AP1177

### Features

- ▶ The seat, the leg rest and the backrest are molded out of cold-foamed integral polyurethane (fireproof) and this allows the maximum comfort for patient in order to prevent decubitus ulcers.
- ▶ Synchronised bilateral control for back rest and leg rest
- ▶ Backrest is equipped with push handle.
- ▶ Armrests are padded and upholstered.
- ▶ All materials are treated with anti-bacterial additive INTERPON.
- ▶ ANTI-SHOCK or TRENDELENBERG position:
  - Backrest from -5° to +100°
  - Leg-rest from -90° to +14°



## Reclining Phlebotomy Chair

### Electric operation

The armchair is entirely made of tubular steel varnished with epoxy powders which allow high mechanical, chemical and corrosion resistance. The backrest has a steel structure, while the leg rest and seat are made of solid anti-humidity multilayer beech-wood panels, consisting of several sheets and wood fibres.

## AP1177

# £1945

ex VAT & delivery



\*Available with 2 or 4 braked wheels (2 as standard)

## MR2000 Spare Pad for Arm Rest

# £56

ex VAT & delivery



### UPHOLSTERY COLOURS:

Please specify colour when ordering.

VANILLE	SAFRAN	ORANGE	ROT	DELFT
TÜRKIS	AZUR	PARAKEET	PISTAZIE	GRAU

\*This item is delivered cased and palletised.

### DIMENSIONS

WIDTH	LENGTH	DEPTH	WEIGHT
75cm	95cm	144cm	65Kg
with backrest down			
75cm	192cm	95cm	65Kg

**SAFE WORKING LOAD 150Kg**

AP1179

## Reclining Phlebotomy Chair

### Electric operation

The armchair is entirely made of tubular steel varnished with epoxy powders which allow high mechanical, chemical and corrosion resistance. The backrest has a steel structure, while the leg rest and seat are made of solid anti-humidity multilayer beech-wood panels, consisting of several sheets and wood fibres.

### Features

- ▶ The seat, the leg rest and the backrest are molded out of cold-foamed integral polyurethane (fireproof) and this allows the maximum comfort for patient in order to prevent decubitus ulcers.
- ▶ Backrest is equipped with push handle.
- ▶ Armrests are padded and upholstered.
- ▶ All materials are treated with anti-bacterial additive INTERPON.
- ▶ ANTI-SHOCK or TRENDELENBERG position:
  - Backrest from -5° to +100°
  - Leg-rest from -90° to +14°

AP1179  
**£2250**  
 ex VAT & delivery

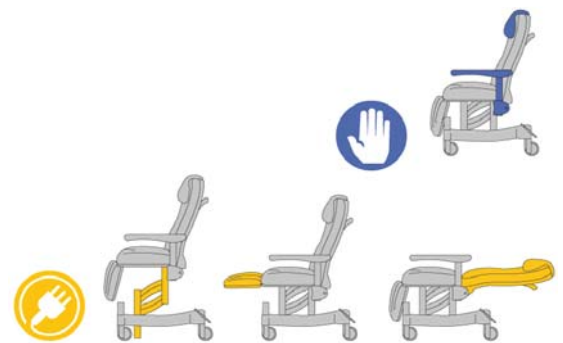

**MR2000 Spare Pad for Arm Rest**  
**£56**  
 ex VAT & delivery



\*Available with 2 or 4 braked wheels  
 (2 as standard)

**UPHOLSTERY COLOURS:**  
 Please specify colour when ordering.



\*This item is delivered cased and palletised.

DIMENSIONS			
WIDTH	LENGTH	DEPTH	WEIGHT
72cm	90cm	123cm	35Kg
with backrest down			
72cm	174.5cm	72cm	35Kg

**SAFE WORKING LOAD 150Kg**

## Reclining Phlebotomy Chair

### Manually adjustable

#### Features

- Manual adjustment between upright and horizontal positions
- Armrests are adjustable for height, tilt and rotation. They may be rigidly clamped in any position or removed entirely
- Optional set of 4 wheels (2 lockable) are available for ease of movement

#### Specifications

- Chromed steel frame
- Back and leg rests are manually operated
- Seat height 62cm (with or without wheels)
- Length of seat extended:165cm

Chair shown in upright position



## 21180 CHAIR

# £605

exc VAT & Delivery\*



Optional set of 4 wheels (2 lockable):

**£138**

exc. VAT & Delivery

#### DIMENSIONS

LENGTH	WIDTH	HEIGHT	WEIGHT
80cm	60cm	135cm	25kg

#### UPHOLSTERY COLOURS:

Please specify code and colour when ordering.

61	63	66	67	71	81
82	83	84	85	86	87

\*This item is delivered cased and palletised.

**THIS CHAIR IS FOR LIGHT USAGE**  
(1-50 PATIENTS PER DAY)

Max. patient weight: 20 stone (127kg)

Patients should avoid using the chair arms for support when leaving the chair.



## Reclining Phlebotomy Chair

### Manually adjustable with headrest

#### Features

- ▶ Fitted with cushioned headrest and contoured seating for extra comfort and security
- ▶ Manual adjustment between upright and horizontal positions
- ▶ Armrests are adjustable for height, tilt and rotation. They may be rigidly clamped in any position or removed entirely
- ▶ Optional set of 4 wheels (2 lockable) are available for ease of movement

#### Specifications

- Chromed steel frame
- Back and leg rests are manually operated
- Seat height 62cm (with or without wheels)
- Length of seat extended: 165cm

## 21182 Chair

**£720**

exc VAT & Delivery\*

#### DIMENSIONS

LENGTH	WIDTH	HEIGHT	WEIGHT
80cm	60cm	135cm	25kg

#### UPHOLSTERY COLOURS:

Please specify code and colour when ordering.

61	63	66	67	71	81
82	83	84	85	86	87

Ergonomic contoured upholstery & headrest



Optional set of 4 wheels (2 lockable):

**£138**

exc. VAT & Delivery

\*This item is delivered cased and palletised.

**THIS CHAIR IS FOR LIGHT USAGE**  
(1-50 PATIENTS PER DAY)

**Max. patient weight: 20 stone (127kg)**

Patients should avoid using the chair arms for support when leaving the chair.



# INMO 21255

## Reclining Phlebotomy Chair

### Hydraulic operation

#### Features

- Hydraulic height operation
- Extremely strong steel mainframe
- Armrests are fully adjustable
- Achieves Trendelenburg position
- Concealed lockable wheels
- Steel structure with epoxy coating
- Backrest and footrest gas-spring operated
- Electric reclining seat
- Adjustable armrests
- Hydraulic adjustable height from 55cm to 85cm

### 21255 Chair

**£2230**

exc VAT & Delivery\*

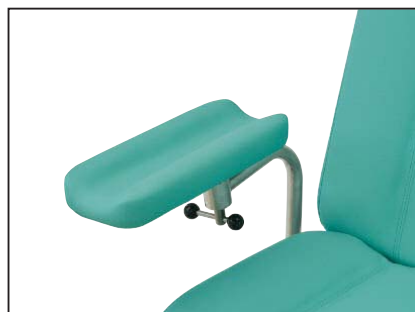
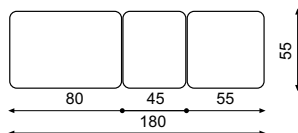
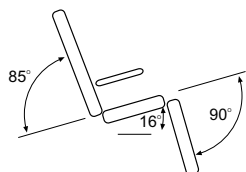

#### DIMENSIONS

LENGTH	WIDTH	WEIGHT
180cm	55cm	45kg

\*This item is delivered cased and palletised.

#### UPHOLSTERY COLOURS:

Please specify code and colour when ordering.

61	63	66	67	71	81
82	83	84	85	86	87

**THIS CHAIR IS FOR MEDIUM-HEAVY USAGE**  
(1-100 PATIENTS PER DAY)

Max. patient weight: 23 stone (150kg)

Patients should avoid using the chair arms for support when leaving the chair.

**INMO 21250**



**Reclining Phlebotomy Chair**  
**Electric operation**

Features

- ▶ Electric height operation
- ▶ Extremely strong steel mainframe
- ▶ Armrests are fully adjustable
- ▶ Achieves Trendelenburg position
- ▶ Concealed lockable wheels

Specifications

- Painted steel frame
- Height is electrically adjusted from 55cm to 85cm
- Back and leg rest adjustments are gas-spring assisted

**21250 Chair**  
**£2330**

exc VAT & Delivery\*

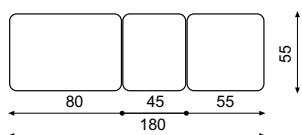
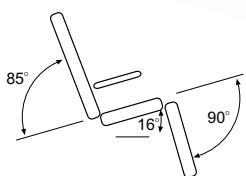

**DIMENSIONS**

LENGTH	WIDTH	WEIGHT
180cm	55cm	35kg

	↔ cm	↗ cm	↕ cm	⚖ kg	⊠ m <sup>3</sup>
<b>21250</b>	180	80	55-85	35	0,84
<b>21255</b>	180	80	55-85	45	0,84

**UPHOLSTERY COLOURS:**

Please specify code and colour when ordering.

<b>61</b>	<b>63</b>	<b>66</b>	<b>67</b>	<b>71</b>	<b>81</b>
<b>82</b>	<b>83</b>	<b>84</b>	<b>85</b>	<b>86</b>	<b>87</b>

\*This item is delivered cased and palletised.

**THIS CHAIR IS FOR HEAVY USAGE**  
 (1-200 PATIENTS PER DAY)  
**Max. patient weight: 30 stone (200kg)**

Patients should avoid using the chair arms for support when leaving the chair.

## Reclining Phlebotomy Chair

A new innovation in phlebotomy chairs

- ▶ Patients settle easily thanks to low chair position and support handles
- ▶ Self-adjustable armrests are comfortable and pleasant to touch as well as easy to clean and maintain
- ▶ The chair is easily set into trendelenburg position by a shock lever. The lever is pushed by foot so that hands stay free to help the patient
- ▶ Individually lockable castors (125mm)
- ▶ Synchronised hydraulic back and leg section

### BON-R

with wheels

# £1955

exc VAT & Delivery\*

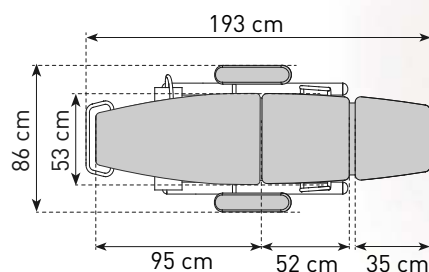
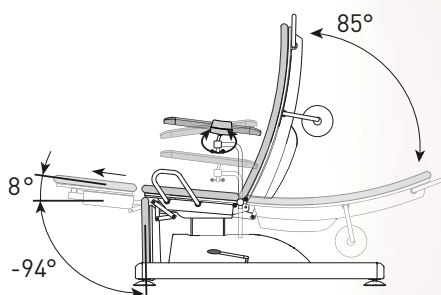

### DIMENSIONS

SITTING HEIGHT	WEIGHT
46cm	90kg

### UPHOLSTERY COLOURS:

Please specify code and colour when ordering.

<b>56009</b> BEIGE	<b>56051</b> YELLOW	<b>56054</b> DEEP RED	<b>56080</b> PEACH	<b>56036</b> JADE
<b>56048</b> LIME	<b>56037</b> LAVENDER	<b>56041</b> PETROL BLUE	<b>56066</b> NAVY BLUE	<b>56032</b> MID GREY

\*This item is delivered cased and palletised.

**THIS CHAIR IS FOR HEAVY USAGE**  
(1-200 PATIENTS PER DAY)

Max. patient weight: 45 stone (300kg)

Patients should avoid using the chair arms for support when leaving the chair.

## Reclining Phlebotomy Chair Electrically operated

A new innovation in phlebotomy chairs

- ▶ Patients settle easily thanks to low chair position and support handles
- ▶ Self-adjustable armrests are comfortable and pleasant to touch as well as easy to clean and maintain
- ▶ Individually lockable castors (125mm)
- ▶ Electric synchronised back and leg section



### TYN-SIN-LE-R

with wheels

## £3200

exc VAT & Delivery\*

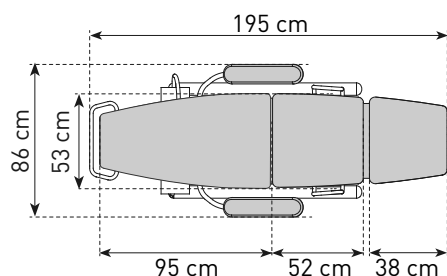
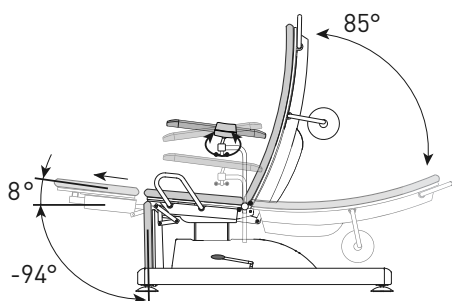

#### DIMENSIONS

SITTING HEIGHT	WEIGHT
48cm to 88cm	105kg



\*This item is delivered cased and palletised.

#### UPHOLSTERY COLOURS:

Please specify code and colour when ordering.

<b>56009</b> BEIGE	<b>56051</b> YELLOW	<b>56054</b> DEEP RED	<b>56080</b> PEACH	<b>56036</b> JADE
<b>56048</b> LIME	<b>56037</b> LAVENDER	<b>56041</b> PETROL BLUE	<b>56066</b> NAVY BLUE	<b>56032</b> MID GREY

**THIS CHAIR IS FOR HEAVY USAGE**  
(1-200 PATIENTS PER DAY)  
Max. patient weight: 30 stone (200kg)

Patients should avoid using the chair arms for support when leaving the chair.